

Article number: 12318000080160

Description: KLEE-coil 318 000 080.160  
M8 Hardened/zinc-plated slotted pin

## Measures

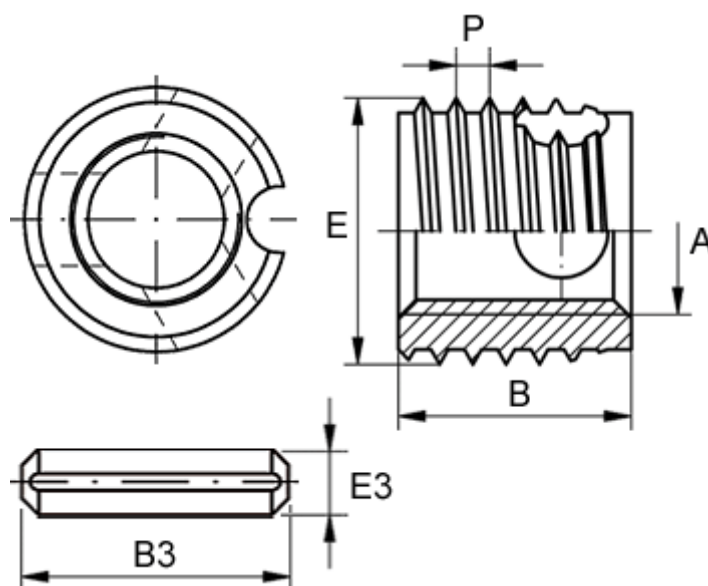

Female thread A	= M8
Length B	= 14
Male thread E	= 12.0
Min hole depth blind hole	= 17
Slotted pin B3	= 10
Slotted pin E3	= 2
Thread pitch P	= 1.50
Type	= 318 000 080 ...